

**PRODUCT SPECIFICATIONS**

Elkay Dependabilt Stainless Steel 39" x 19-13/16" x 43-3/4" 16 Gauge Three Compartment Sink with Stainless Steel Legs. Sink is manufactured from 16 gauge 300 series Stainless Steel with a #4 Finish, Center drain placement.

<b>Material:</b>	300 series Stainless Steel
<b>Finish:</b>	#4 Finish
<b>Gauge:</b>	16
<b>Weight Without Packaging:</b>	102
<b>Number of Bowls:</b>	3
<b>Sink Dimensions:</b>	39" x 19-13/16" x 43-3/4"
<b>Bowl 1 Dimensions:</b>	10" x 14" x 10"
<b>Bowl 2 Dimensions:</b>	10" x 14" x 12"
<b>Bowl 3 Dimensions:</b>	10" x 14" x 12"
<b>Drainboard Location:</b>	No drainboard
<b>Backsplash Height:</b>	10
<b>Leg Type:</b>	Stainless Steel
<b>Drain Size:</b>	3-1/2" (89mm)
<b>Drain Location:</b>	Center

**Special Note:** Requires single splash mount faucet (not included).

<b>Custom Options</b>	
<b>Alternate Punching</b>	
<input type="checkbox"/> Faucet Model:	<input type="checkbox"/> Punch Required:

\*Options available if applicable



**Included with Product:** Stainless steel legs and adjustable bullet feet.

**AMERICAN PRIDE. A LIFETIME TRADITION.**  
Like your family, the Elkay family has values and traditions that endure. For almost a century, Elkay has been a family-owned and operated company, providing thousands of jobs that support our families and communities.

**Product Compliance:** ASME A112.19.3/CSA B45.4  
NSF 2

**Accessory:** ASME A112.18.2/CSA B125.2

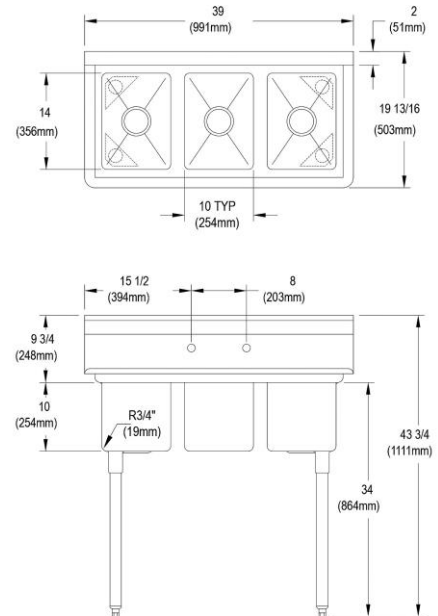

PART: \_\_\_\_\_ QTY: \_\_\_\_\_

PROJECT: \_\_\_\_\_

CONTACT: \_\_\_\_\_

DATE: \_\_\_\_\_

NOTES: \_\_\_\_\_

APPROVAL: \_\_\_\_\_

*In keeping with our policy of continuing product improvement, Elkay reserves the right to change product specifications without notice. Please visit [elkay.com](http://elkay.com) for the most current version of Elkay product specification sheets. This specification describes an Elkay product with design, quality, and functional benefits to the user. When making a comparison of other producers' offerings, be certain these features are not overlooked.*